

Design and comparative analysis of Inter Satellite-Optical Wireless Communication (IS-OWC) for Return to Zero (RZ) & Non-Return to Zero (NRZ) modulation formats through channel diversity technique

Nirmal Jothi¹, Santhana Krishnan², Lakshminarayanan³

¹*Department of Electronics and Communication Engineering, Vel Tech Rangarajan, Dr.Sagunthala R&D Institute of science and technology, Tamilnadu, India*

²*Department of Electronics and Communication Engineering, SCAD College of Engineering and technology, Tirunelveli, Tamilnadu, India*

³*Department of Electronics and Communication Engineering, Francis Xavier Engineering College, Tirunelveli, Tamilnadu, India*

Abstract: Inter-Satellite Optical Wireless Communication (IS-OWC) is a novel strategy for establishing an inter-connection between two satellites. The IS-OWC is focused on the use of lasers rather than conventional radio and microwave structures for wireless optical communication. Optical wireless communication between satellites is being developed by integrating optical wireless communication technology and space technology. IS-OWC can connect satellites in the same orbit or different orbits. When compared to the single channel, the channel diversity strategy produces better results. The channel diversity techniques use the IS-OWC devices, in which several signal paths are available for allowing the Q factor and signal intensity, which is extended or enlarged over a large distance. In this paper, the Q factor and Bit Error Rate (BER) are reviewed with diverse modulation designs for Return to Zero (RZ) and Non-Return to Zero (NRZ) using the channel diversity technique. The simulation is conducted on opti-system-16.0 software with 32768 numbers of samples with a bit rate of 109 bits/sec. The Q factor attained a maximum in the 8-channel OWC is 19.4385, whereas the Q factor attained minimum in the 2-channel OWC is 19.4385. Moreover, the number of channels increased may develop the proficiency of minimum power inter-satellite relation.

Keywords: Optical Wireless Communication (OWC), BER, Q-factor, Return to Zero (RZ), Non-Return to Zero (NRZ).

Zasnova in primerjalna analiza medsatelitsko-optičnih brezžičnih komunikacij (IS-OWC) za modulacijske formate povratek v ničlo (RZ) in nepovratek v ničlo (NRZ) s tehniko kanalske raznolikosti

Izvleček: Medsatelitska optična brezžična komunikacija (IS-OWC) je nova strategija za vzpostavitev medsebojne povezave med dvema satelitoma. IS-OWC se osredotoča na uporabo laserjev namesto običajnih radijskih in mikrovalovnih struktur za brezžično optično komunikacijo. Optična brezžična komunikacija med sateliti se razvija s povezovanjem tehnologije optične brezžične komunikacije in vesoljske tehnologije. IS-OWC lahko povezuje satelite v isti orbiti ali različnih orbitah. V primerjavi z enim kanalom daje strategija raznolikosti kanalov boljše rezultate. Tehnike kanalske raznolikosti uporabljajo naprave IS-OWC, v katerih je na voljo več signalnih poti za omogočanje faktorja Q in intenzivnosti signala, ki se poveča na veliki razdalji. V tem članku sta raziskana faktor Q in stopnja napake v bitu (BER) z različnimi modulacijskimi zasnovami za vrnitev v nič (RZ) in brez vrnitev v nič (NRZ) z uporabo tehnike kanalske raznolikosti. Simulacija je izvedena s programsko opremo opti-system-16.0 s 32768 vzorci s hitrostjo prenosa 109 bitov na sekundo. Faktor Q, dosežen pri 8-kanalnem OWC, je 19,4385, medtem ko je faktor Q, dosežen pri 2-kanalnem OWC, 19,4385. Poleg tega se lahko s povečanjem števila kanalov razvije spretnost najmanjše moči medsatelitskega razmerja.

Ključne besede: Optične brezžične komunikacije (OWC), BER, faktor Q, povratek v ničlo (RZ), nepovratek v ničlo (NRZ).

* Corresponding Author's e-mail: drnj2023@gmail.com

How to cite:

N. Jothi et al., "Design and comparative analysis of Inter Satellite- Optical Wireless Communication (IS-OWC) for Return to Zero (RZ) & Non-Return to Zero (NRZ) modulation formats through channel diversity technique", Inf. Midem-J. Microelectron. Electron. Compon. Mater., Vol. 53, No. 1(2023), pp. 3–13

1 Introduction

With the utilization of satellite communication shortly, the optical wireless communication mode has undoubtedly evolved. Individual OWC systems have standards due to their outstanding performance [1]. The IS-OWC systems performance multiplexing techniques are used with extended distance transmission. The inter-satellite link of 10 Gbit/s data rate has modelled with 5000 kilometres of communication range [2, 3]. Therefore, the validation of comparative analysis shows that the RZ and NRZ model modulation are changing input power stages [4]. The lightwave system preserves a high data rate for the upcoming generations, and the data rate can grasp user capacity [5]. The network configuration has high speed due to the minimal linear and non-linear distortions by increasing the demand of assert lookup for robust networks. In the case of optical fibers, chromatic diffusion and polarization mode diffusion comprise linear and nonlinear damage such as self and cross-phase modulation and so on. [6, 7]. It is necessary to avoid the optimal modulation design by the narrow optical spectrum and not to resist excessive distortion by improving spatial performance.

The self-phase and cross-phase modulation with the constant optical power modulation format is a smaller amount of susceptible [8]. The amplified spontaneous emission (ASE) in case of long haul optical network, noise enters the image that may reduce and choose the optimum modulation format. The modulation format plays a vital role in communication [9]. Microwave communication system for satellite communication is important assistance over the optical wireless communication (OWC) system is occupied with the communication world in huge applications [10]. The minimum power consumption and extensive distance transmission application are set by the low-cost landmark function in the OWC system and it is tough to organize the extended fiber optic cables [11, 12]. Thus, the effectiveness of the satellite application of the IS-OWC system is compatible with communication training. The communication system is needed to overcome better efficiency in erroneous transmission, power constraints and noise.

The goal of every link involving a communications satellite is to provide the highest-quality signal with the least amount of bandwidth and power while utilising the most suitable technology. In a small-satellite constellation system, the design decreases the system's complexity and implementation costs, lowers the necessary transmission power, which improves the signal-to-noise ratio, and condenses the frequency spectrum. The Starlink satellite broadband communications network created by American company SpaceX is evaluated in this paper. The key technical features of this particular area of

broadband communications networking based on constellations of tiny satellites are examined and discussed. The paper's primary goal is to demonstrate the technical details of the Starlink network that SpaceX withholds in popular-science presentations [13].

IS-OWC system is the adaption of wireless technology in the modern period. Present microwave satellite systems in maximum bandwidth, minimum size, and least power demand offered by the IS-OWC system [14]. The RF signal is compared with the laser signal providing lower loss. Lasers are associated with the RF wavelength [15]. Joining altered positions on the earth's surface is a fascinating objective. The earth station and satellite are establishing a network. Consequently, an inter-satellite link (ISL) contains the energetic influence under the optimal communication implication [16]. Owing to propagation loss being weighty, the time lag in extensive transmission for Geo stationary Earth Orbit (GEO). The globular link and communication function are extremely desirable for the Low Earth Orbit (LEO) as well as Medium Earth Orbit (MEO) satellites [17]. Two satellites in IS-OWC technology act as transmitters and receivers at the propagation channel. The tracking system's highly accurate signal is required for beacon signal and quadrant detector with connected satellite, which makes sure that the tracking system, has orientation and correct line of sight (LOS) [18]. The major problem of the system is closed-loop tracking. Servo motors are addressing the problem and blocking the beacon signals on satellites. The other satellites are expanding the ephemeris data to accurately pinpoint and track the other satellites [19]. The IS-OWC system develops link distance into the modulation system that is utilized for input power level, operation wavelength, receiver sensitivity, and diversity methods. Some of the techniques are used to compensate for the effects that damage the link efficiency [20, 21]. The minimum BER is obtained by the ISL link; a low transmitter divergence is utilized for delivering the greatest power level on the receiver side and removes that difficulty in power degeneracy.

Any two satellites in this connection are used for IS-OWC if the satellite is in a similar orbit or dissimilar orbit. The most common orbits used by the satellite are LEO, MEO and geostationary earth orbit. On the other hand, the tracking system is highly accurate and it is used for the beacon signals on the hand and quadrant detector. The accurate line of sight has aligned and ensures that the linked satellite is propagative. The light travels at 3×10^8 m/s in data that can send without delay and attenuation. The maximum speed of data is transmitted over thousands of kilometres with minor payload with radio frequency (RF) links over the benefits of optical links.

The main contributions of this manuscript are summarized below,

- In this manuscript, the design and comparative analysis of the IS-OWC for RZ and NRZ modulation formats through channel diversity techniques are proposed.
- The IS-OWC is concerned through the employment of lasers based on traditional radio and microwave systems for the OWC.
- When compared to the single channel, the channel diversity strategy produces better results.
- The IS-OWC device uses a diversity technique, in which several signal paths are available, allowing the Q-factor and signal intensity to be extended or increased over a large distance.
- In this manuscript, the Q-factor with BER is estimated with diverse modulation formats, like RZ and NRZ using the channel diversity technique.
- Here, a channel variety strategy with multiple transmitter and receiver antennas is used to investigate the results for various types of adjustment techniques in NRZ and RZ.
- Finally, the experiment is simulated with optisystem-16.0 software. The proposed system is simulated using 32768 numbers samples with a bit rate of 109 bits/sec.

The rest of this manuscript is structured as: Section 2 describes the literature review of various research papers associated with IS-OWC for channel diversity schemes. Section 3 illustrates the proposed IS-OWC for RZ and NRZ modulation through the channel diversity technique. Section 4 demonstrates the experimental outcomes and discussion of the proposed method. At last, section 5 concludes the manuscript.

2 Related Work

Among the various research works on the IS-OWC for channel diversity techniques, some of the most recent works are reviewed here,

In 2020, Singh et al [22] presented the 3D orthogonal modulation scheme by incorporating the bandwidth-efficient with a high-speed IS-OWC link. Here, three autonomous 40 Gbit/s information signals were sent on a similar wavelength channel that was modulated through the parameters of the various signals of the optical carrier. The IS-OWC link efficiency of the presented method has been re-searched for growing point errors with simulation results showing that the presented IS-OWC link was extended until the link distance was 16,000 in the effect of pointing error was 3.5 with satisfactory BER.

In 2018, Sharma et al [23] presented wireless communication in the dynamic field of IS-OWC. In numerous counts of channels under the structure, the Q factor value maximizes as the count of channels maximizes with minimized BER value. In the signal received as dissimilar routes, the strength and capacity of the signal increase with numerous counts of the channel have numerous counts of transmitter and receiver antenna. The performance of the proposed method improved the low power and increased the count of channels.

In 2018, Khichar et al [24] presented the IS-OWC system in filter and amplifier diversity techniques utilized for data transmission. The diversity technique of higher Q factor and improved bit rate was suggested with noise power separation and received noise power amplification. A wavelength of 1550 nm was the modulation of NRZ. The system has 30 dBm input power with a 7000 km link distance over the 40 Gbit/s has improved the data rate. For additional development, under link distance and system data rate were evaluated.

In 2020, Sivakumar et al [25] presented the DSP algorithm to improve the link range with the coherent detection technique for the IS-OWC system based on high-speed single channel PDM-QPSK. Here, the presented method performance in the influence of receiver pointing error with OSNR system demand to achieve the acceptable level of BER maximizes the pointing error angle increases. An efficient IS-OWC transmission system with long-distance and high-speed bandwidth is used.

In 2019, Sri et al [26] presented the revolutionary technique in IS-OWC that establishes genuine communication. Here, the RF satellite links in the knowledge transmit with a similar speed of around Mbps. Therefore, reaching the highest knowledge rate in optical links for homes over optical lasers (OLs) is necessary for exploitation. The light beam from the OLs offers less probability for detective work, interrupting with diminishing the possibility of electronic signal congestion. OISL systems were faster and safer information measures in the transmission of knowledge.

In 2018, Viswanath et al [27] presented that the transmitter power condition was comparatively greater for a greater value of turbulence at ground level. Here, the power demand for uplink was 8-10 dB as likened to downlink. In the event, that transmitter power was required for non-feasibility, it can be transported with possible level through transmitter spatial diversity or MISO approach for the receiver of uplink diversity or SIMO approach for downlink is aperture averaging. The practical relevance of the laser communications satellite launched into geostationary orbit, ground-satellite and satellite-ground links must be recognized.

In 2017, Pradhan et al [28] presented the IS-OWC system for space and polarization diversity methods. Here, 25 dBm input power and 7.63 Gbit/s data rate were achieved for the 6,000 km for link length. The diversity technique was polarized by the performance of system development also evaluated. The system can be evaluated by enhancing link distance with data rate.

3 Proposed methodology

All communication schemes involve a transmitter, propagation medium, and receiver. Two or more satellites are developed by an inter-satellite link that one satellite communicates with another using OWC. Both the satellite transmitter and receiver hold that monitoring system for decreasing signal misalignment. Here, the IS-OWC method with channel diversity technique, a transmitter, a propagation medium and a receiver make up the IS-OWC system. And then the binary signal is generated by a pseudo-random bit sequence (PRBS) that is converted into the electric signal, such as RZ and NRZ in pulse generators. In RZ and NRZ generators through carrier signal (laser light) using modulator Mach - Zender (MZ) supports in modulating the voltage. With the help of a power combiner, the optical signal is propagated to the 1: N fork that provides independent signal copies with N number of OWC. An avalanche photodiode (APD) is utilized in the receiver for converting the optical domain signal with an electric signal. The redundant signal is filtered with Low Pass Bessel Filter (LPBF). For different modulation schemes, the BER analyzer performance is assessed based on the Q factor or BER. Figure 1 portrays the IS-OWC block diagram method with the channel diversity technique.

3.1 Inter satellite-optical wireless communication (IS-OWC)

This is utilized for the carrier signal to transmit the signal as laser light. The system is dependent on numerous limitations, such as laser light wavelength, transmitted power, modulation technique in different types, antenna size of the receiver and transmitted signal. The laser light signal is utilized to deliver wireless connectivity between the source and the destination. The free - space is the medium utilized here to take the message. The receiver signal power level in the IS-OWC system is calculated [18] using equation (1)

$$Q_S = W_Q W_F S_F W_H S_H W_K S_K \left(\frac{\omega}{4\pi S} \right)^2 \quad (1)$$

Where QS represents the received power, WQ represents the transmitted power, WF describes the optical

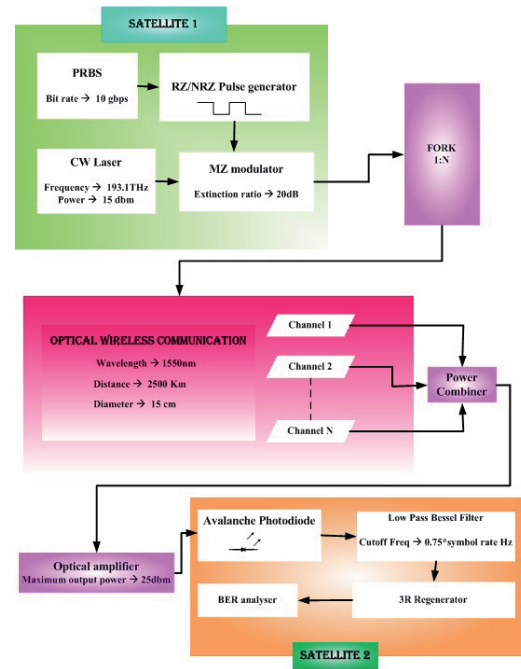

Figure 1: Block diagram of the IS-OWC method with the channel diversity technique.

performance of transmitter signal, SF describes that optical performance of receiver signal, WH denotes that transmitter signal gain, SH denotes that receiver signal gain, WK indicates the transmitter pointing loss factor, SK indicates the receiver pointing loss factor, ω represents the operational wavelength, S represents the link distance among the transmitter and receiver.

3.2 Flow chart

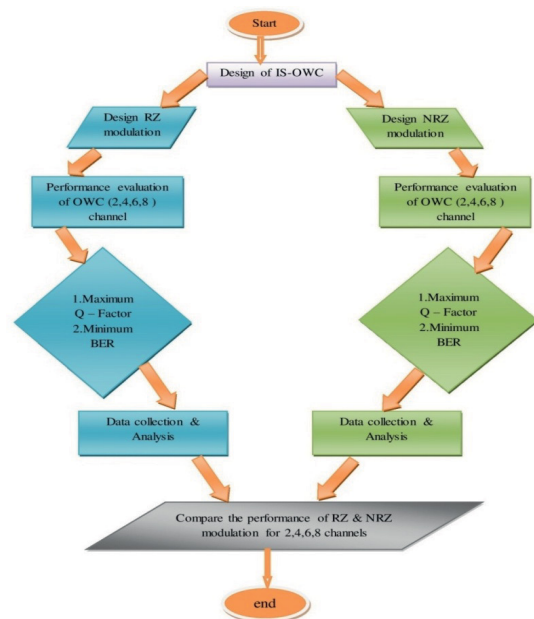

Figure 2: Flow chart of IS-OWC system using channel diversity technique

3.3 Return to zero modulation format

A pseudorandom pulse generator produces the information to be broadcasted in the structure of binary data and comprises the layout that designates the transmitted segment. The binary data is served into a return to zero pulse generator, which converts it into the electrical pulses for transmission. RZ pulse generator output is directed to an MZ modulator. The MZ modulator modulates the electrical pulse through a continuous wave laser with 1,550 nm. The main use of the optical antenna is the optical signal output in the MZ modulator that is directed near the n-OWC channel. The IS-OWC link's receiving end consists of an optical receiving antenna that receives the incoming signal. The signal is guided to a photodiode called APD that transforms the optical domain signal (ODS) into its electrical equivalent. A Bessel low-pass filter surveys the APD photodiode, and then high-frequency noise in the received signal is eliminated. The Q-factor, BER, and SNR of the received signal are calculated using the BER analyzer.

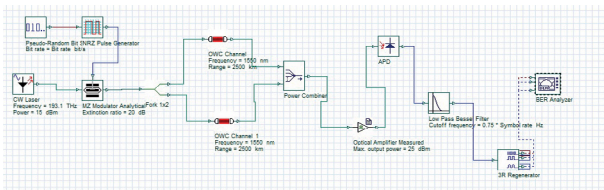

Figure 3: Layout diagram of 2-OWC

Figure 3 shows the layout diagram of 2 channels OWC for return to zero modulation. In this, the binary signal is generated by the PRBS that is converted into an electric signal via pulse generator RZ. The MZ modulator helps modulate the voltage of the RZ generator through the carrier signal (laser light) extinction ratio of 20 dB. And then the carrier signal is converted into two channels with a frequency of 1550 nm and a range of 2500 km. With the help of a power combiner, the optical signal has been propagated to an optical amplifier measured with a maximum output power of 25 dBm. An APD is used in the receiver for converting ODS with an electric signal. The redundant signal is filtered out using LPBF. For the modulation scheme, the performance of the BER analyzer rate is 6.4925×10^{-15} .

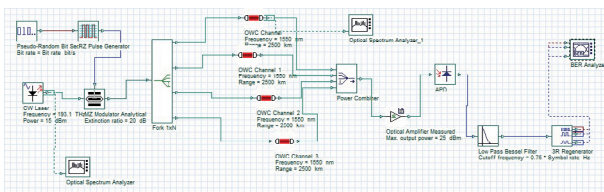

Figure 4: Layout diagram of 4-OWC

Figure 4 shows the layout diagram of 4 channels OWC for return to zero modulation. Here, the optical signal propagates with a 1: N fork that provides independent signal replicates with N number of OWC and the signal is converted into four channels with a frequency of 1550 nm and a range of 2500 km. For the modulation scheme, the performance of the BER analyzer rate is 1.96543×10^{-30} .

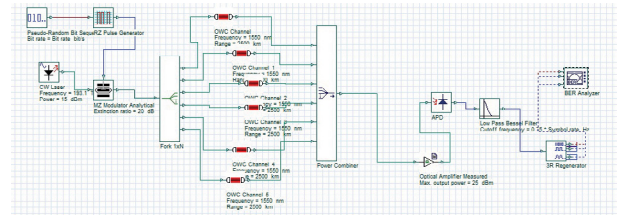

Figure 5: Layout diagram of 6-OWC

Figure 5 shows the layout diagram of 6 channels OWC for return to zero modulation. Here, the binary signal is generated through PRBS that is converted into an electric signal via pulse generator RZ. The MZ modulator helps in modulating the voltage of the RZ generator with carrier signal in the extinction ratio of 20 dB. For the modulation scheme, the performance of the BER analyzer rate is 8.58148×10^{-52} .

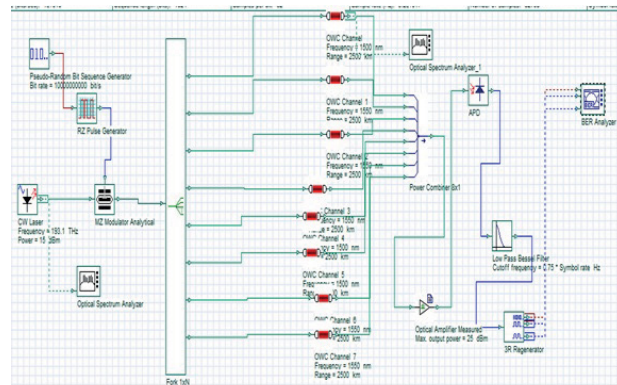

Figure 6: Layout diagram of 8-OWC

Figure 6 shows the layout diagram of 8 channels OWC for return to zero modulation. The optical signal propagates with a 1: N fork that provides independent signal replicas with N number of OWC, and the signal is converted into eight channels with a frequency of 1550 nm and a range of 2500 km. By using the power combiner, the optical signal has been propagated to the optical amplifier measured with the maximum output power of 25 dBm. An APD is used in the receiver for converting ODS with an electric signal. The redundant signal is filtered using LPBF. For the modulation scheme, the performance of the BER analyzer rate is 3.29942×10^{-66} .

3.4 Non return to zero modulation layouts

The binary signal is made by the PRBS that is transformed using an electrical signal via an NRZ pulse generator. The NRZ generator output is modulated by the carrier signal utilizing the MZ modulator, which is propagated optically to Fork 1: N, it provides the N number of the optical wireless channel and separates the signal imitations utilizing the power combiner. An APD is used in the receiver for converting ODS with an electric signal. The removal of an unwanted signal is used by the LPBF. Then the use of the BER analyzer is a view of the results of the Q factor or BER form. The efficiency of the proposed method improves the number of channels, and transmitters and increases the receiver antenna.

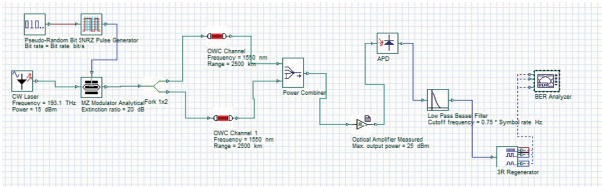

Figure 7: Layout diagram of 2-OWC

Figure 7 shows the layout diagram of 2 channels OWC for non-return to zero modulation. For the modulation scheme, the performance of the BER analyzer rate is 1.34606×10^{-020} .

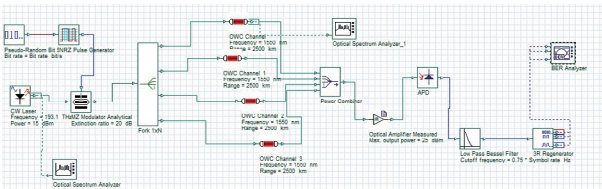

Figure 8: Layout diagram of 4-OWC

Figure 8 shows the layout diagram of 4 channels OWC for non-return to zero modulation. For the modulation scheme, the performance of the BER analyzer rate is 5.53168×10^{-044} .

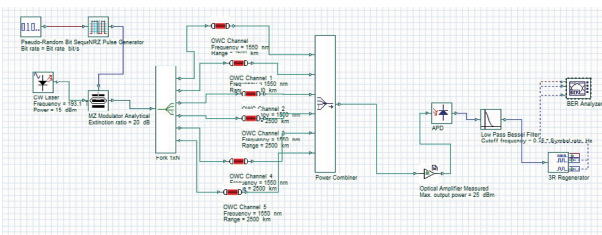

Figure 9: Layout diagram of 6-OWC

Figure 9 shows that the layouts diagram of 6 channel OWC for non-return to zero modulation. For the mod-

ulation scheme, the performance of the BER analyzer rate is 8.86894×10^{-064} .

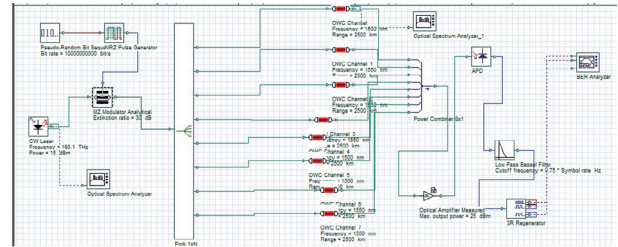

Figure 10: Layout diagram of 8-OWC

Figure 10 shows the layout diagram of 8 channels OWC for non-return to zero modulation. Here, the performance of the BER analyzer rate is 1.67178×10^{-088} .

4 Results and discussion

This section describes the implementation of the experiment and carried out the details. The simulation is performed in opti-system-16.0 software. And the simulation parameters utilized under experiments are tabulated in Table 1. Here, table 1 por-trays the simulation parameters advanced to im-plement the proposed IS-OWC system. Continuous wave laser (CWL) utilized a source with 193.1 THz transmitted frequency. The proposed method is simulated with 32768 samples with 109 bits/sec bit rate. The transmitter frequency 100 GHz spacing with the transmitted power is 15 dBm is occupied and 1550 nm wavelength is used for simulation.

4.1 Performance evaluation

The performance measures such as gain, pointing loss, bit error rate (BER) are discussed below,

4.1.1 Gain

The antenna gain is the measure of effectiveness that is maximum with the antenna can emit the de-livered power by the transmitter side, and the transmitter is given [23] by equation 2

$$H'_w = \left(\frac{\pi d_w}{\omega} \right)^2 \tag{2}$$

The gain of the receiver side antenna is given by equation 3,

$$H'_s = \left(\frac{\pi d_s}{\omega} \right)^2 \tag{3}$$

Where, d_w represents the transmitter telescope diameter, d_s denotes the diameter of the destina-tion of tel-escape.

Table 1: Simulation parameters

Parameter	Value
Simulation Window	
Bit Rate	109 bits/sec
Samples number	32768
Transmitter	
Frequency	193.1 THz
Laser	CWL
Spacing Frequency	100GHz
Power	15dBm
Extinction ratio	20dB
Line width	0.01MHz
Type of Modulation	RZ/NRZ
Optical Wireless Channel	
Range	2500km
Wavelength	1550nm
Transmitter Aperture diameter	15cm
Receiver Aperture diameter	15cm
Attenuation	0
Optical Efficiency	1
Transmitter & Receiver Pointing Error	1.1 μrad
Additional losses	1.5dB
Propagation delay	0
Receiver	
Responsivity of APD	1 A/W
Cut off frequency (LPBF)	0.72*Symbol Rate in Hz

4.1.2 Pointing loss

The transmitter side of pointing loss [2] is calculated by given equation,

$$K_w = e^{-H_w \epsilon_w} \tag{4}$$

The receiver side of pointing loss [2] is calculated by given equation,

$$K_s = e^{-H_s \epsilon_s} \tag{5}$$

Where, H_w and H_s implicates the pointing errors of transmitter and receiver respectively.

4.1.3 Bit Error Rate (BER)

System representation indicates the BER and communication quality in the OWC system. The acceptable signal level includes below 10^{-9} of the BER value. Subsequently, the BER value for the optical system is less; it is hard for analyzing the Q factor employed as the performance of the system. Q factor contains a straight relationship through the BER signal [15].

$$BER = \frac{1}{2} \operatorname{erfc} \left(\frac{Q}{\sqrt{2}} \right) \tag{6}$$

$$BER = \frac{e^{-\frac{Q^2}{2}}}{Q\sqrt{2\pi}} \tag{7}$$

4.2 Q-factor analysis for RZ and NRZ

Figure 12 and 13 shows the Q factor modulation formats in RZ and NRZ system. Based on the eye diagram the channel 2, 4, 6 and 8 results in RZ with NRZ formats are shown below. The “eye” of the digital signal of a human eye is formed on an oscilloscope, which displays the transmission system output, and the eye reflects the consistency of SNR at the “eye” of a digital signal. The sampling process with the largest “eye-opening” is the best place to determine if a given bit is “1” or a “0.” The largest “eye-opening,” is higher variance among the mean values of signal levels for “1” and “0.” The eye diagram for channels 2, 4, and 6 furnishes a small eye-opening, which means that the Inter Symbol Interference (ISI) is high. The eye diagram of channel 8 provides a big opening that refers to the ISI being low.

4.2.1 2 and 4 channel Q factor analysis

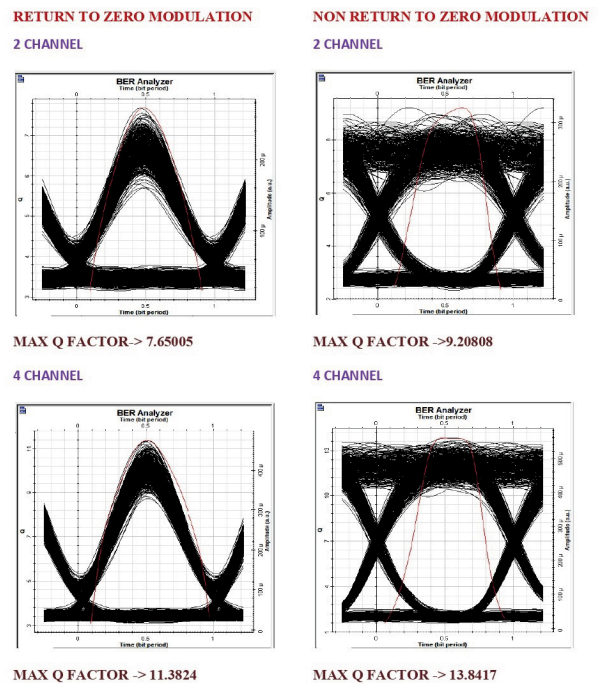

Figure 11: Maximum Q-factor of 2 and 4 Channel for RZ with NRZ modulation

Figure 11 shows the maximum Q factor in the second channel and fourth channel for RZ and NRZ modulation. Q factor and BER denote the converse relationship

in the 2 and 4-channel modulation schemes. Here, two channels in re-tun to zero modulation produce the maximum Q factor value is 7.65005, two channels in non-return to zero modulation produce the maximum Q factor value is 9.20808, four channels in return to zero modulation produce the maximum Q factor value is 11.3824, simi-larly, four channels in non-return to zero modulation produces the maximum Q factor value is 13.8417.

4.2.2 6 and 8 channel Q factor analysis

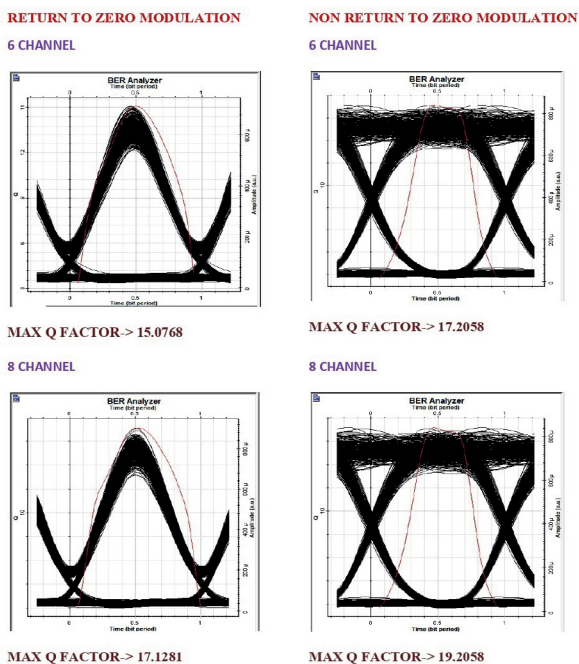

Figure 12: Maximum Q-factor of 6 and 8 Channel for RZ with NRZ modulation

Figure 12 depicts the maximum Q factor in the sixth channel and eighth channel for RZ and NRZ modulation. Q factor with BER denotes the converse relationship in the 6 and 8-channel modulation scheme. Here, the sixth channels in return to zero modulation produce the maximum Q factor value is 15.0768, the sixth channels in non-return to zero modulation produce the maximum Q factor value is 17.2058, eight channels in return to zero modulation produce the maximum Q factor value is 17.1281, similarly, eight channels in non-return to zero modulation produces the maximum Q factor value is 19.2058. Figure 12 depicts the maximum Q factor in the sixth channel and eighth channel for RZ and NRZ modulation. Q factor with BER denotes the converse relationship in the 6 and 8-channel modulation scheme. Here, the sixth channels in return to zero modulation produce the maximum Q factor value is 15.0768, the sixth channels in non-return to zero modulation produce the maximum Q factor value is 17.2058,

eight chan-nels in return to zero modulation produce the max-imum Q factor value is 17.1281, similarly, eight channels in non-return to zero modulation produces the maximum Q factor value is 19.2058.

4.3 BER Analysis for RZ & NRZ

Figures 13 and 14 show the minimum BER of channels 2, 4, 6 and 8 of RZ and NRZ modulation format. The BER specifies the possibility of wrong bit identification through the decision circuit. The design of OWC systems depends on performance estimation like BER figures. The channel comparison 2, 4, 6 and 8 suggests that the bit error rate is within the minimum target.

4.3.1 2 and 4 channel BER analysis

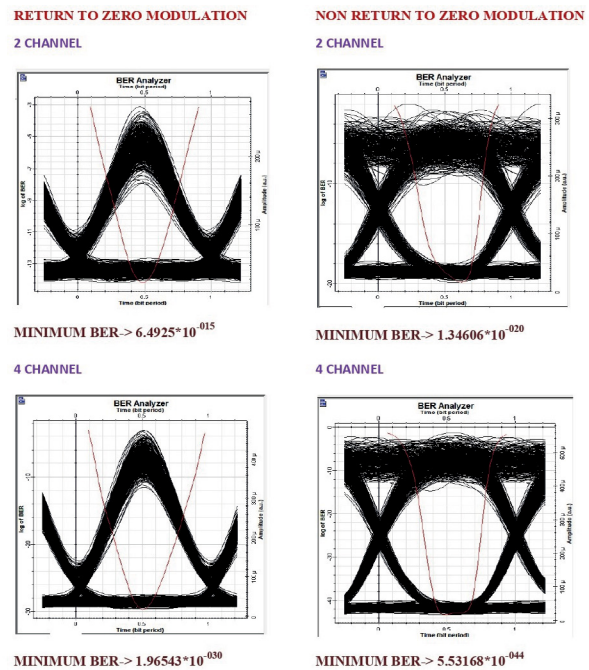

Figure 13: Minimum BER of 2 and 4 channel for RZ and NRZ modulation

Figure 13 shows the minimum BER in the second channel and fourth channels for RZ and NRZ modulation. Q factor and BER are the converse relationship in the 2 and 4-channel modulation scheme. Here, two channels in RZ modulation produce that mini-mum BER value indicates, two channels in NRZ modulation produce that minimum BER value indicates, four channels in RZ modulation produce that mini-mum BER value is, similarly four channels in NRZ modulation produces that minimum BER value indi-cates. 5053168*10-044

4.3.2 6 and 8 channel BER analysis

Figure 14 shows the minimum BER in the sixth channel and eighth channel for RZ and NRZ modulation. Q

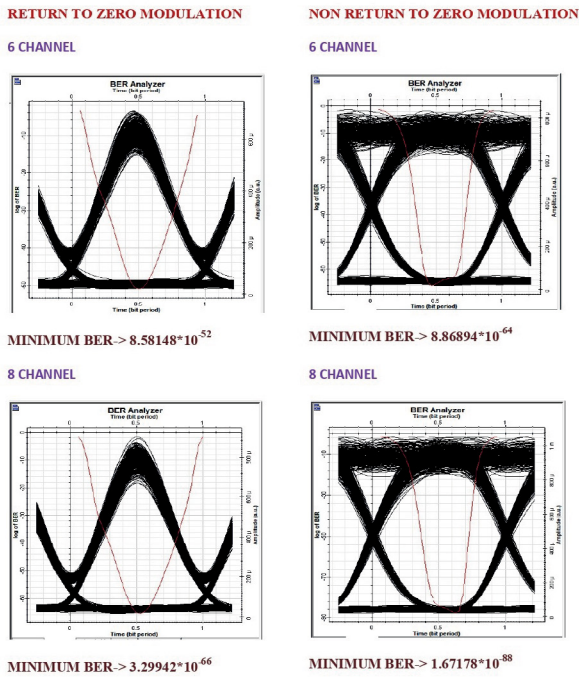

Figure 14: Minimum BER of 6 and 8 channel for RZ and NRZ modulation

factor and BER indicate the converse relationship in the 6 and 8-channel modulation schemes. Here, the sixth channels in RZ modulation produce that minimum BER value indicates, sixth channels in NRZ modulation produce that minimum BER value is, eight channels in RZ modulation produce that minimum BER value indicates, similarly eight channels in NRZ modulation produce that minimum BER value indicates 1.67178-10-88.

5 Conclusions

In this manuscript, the comparative analysis of IS-OWC for RZ and NRZ modulation formats for channel diversity techniques is proposed. An n-channel IS-OWC system functioning at 10 Gbit/s with several inflexions setups for 15 dBm instance of power is encompassed in the modeled scheme. The Inter-satellite signals are improved and let they portable to extended distances are done by connecting several OWC channels between the transmitter and the receiver. In an optical wireless communication device, the NRZ modulation is much superior to RZ modulation since in this BER is lesser and the Q factor is higher. The Q factor attained a maximum in the 8-channel OWC is 19.4385, whereas the Q factor attained minimum in the 2-channel OWC is 19.4385. Moreover, the increased number of channels may develop the proficiency of low power inter-satellite relations.

6 Conflict of Interest

The author of this document does not have any Conflict of Interest (COI) in publishing this paper.

7 References

1. Kaur, R. and Kaur, H., 2018. Comparative analysis of chirped, AMI and DPSK modulation techniques in IS-OWC system Optik, 154, pp.755-762 <https://doi.org/10.1016/j.ijleo.2017.10.108>
2. Kumari, G. and Selwal, C., 2018. Performance Improvement in Inter-satellite Optical Wireless Communication to Mitigate Losses Using Diversity Technique, In Optical and Wireless Technologies (pp. 375-382).Springer, Singapore https://doi.org/10.1007/978-981-10-7395-3_42
3. Karpagarajesh, G., Blessie, A. and Krishnan, S., 2021. Performance Assessment of Dispersion Compensation Using Fiber Bragg Grating and Dispersion Compensation Fiber Techniques. Informacije MIDEM, 51(4), pp.215-223. <https://doi.org/10.33180/InfMIDEM2021.402>
4. Kong, M., Kang, C.H., Alkhazragi, O., Sun, X., Guo, Y., Sait, M., Holguin-Lerma, J.A., Ng, T.K. and Ooi, B.S., 2020. Survey of energy-autonomous solar cell receivers for satellite-air-ground-ocean optical wireless communication, Progress in Quantum Electronics, p.100300 <https://doi.org/10.1016/j.pquantelec.2020.100300>
5. Escribano, F.J., Wagemakers, A., Kaddoum, G. and Evangelista, J.V., 2020. A spatial time-frequency hopping index modulated scheme in turbulence-free optical wireless communication channels. IEEE Transactions on Communications, 68(7), pp.4437-4450 <https://doi.org/10.1109/TCOMM.2020.2987561>
6. Kaur, R. and Kaler, R.S., 2020. Performance of zero cross correlation resultant weight spectral amplitude codes in lower Earth orbit-based optical wireless channel system. International Journal of Communication Systems, 33(12), p.e4456 <https://doi.org/10.1002/dac.4456>
7. Zhu, C., Li, Y., Zhang, M., Wang, Q. and Zhou, W., 2020, May. An Optimization Method for the Gateway Station Deployment in LEO Satellite Systems. In 2020 IEEE 91st Vehicular Technology Conference (VTC2020-Spring) (pp. 1-7).IEEE. <https://doi.org/10.1109/VTC2020-Spring48590.2020.9128413>
8. Dubey, D., Prajapati, Y.K. and Tripathi, R., 2020. Error performance analysis of PPM-and FSK-based hybrid modulation scheme for FSO satellite down-

- link. *Optical and Quantum Electron-ics*, 52, pp.1-16
Optical and Quantum Electron-ics (2020) 52:286
<https://doi.org/10.1007/s11082-020-02404-7>
9. Garg, N. and Ahmad, A., 2021. Performance of Outdoor Optical Wireless Communication Channel through Gamma-Gamma Turbulence at Different Frequency In *Advances in Electromechanical Technologies* (pp. 551-560). Springer, Singapore
https://doi.org/10.1007/978-981-15-5463-6_49
 10. Karpagarajesh, Guruviah, and Helen Anita. "Maximizing the area spanned by the optical SNR of the 5G using digital modulators and filters." *Int. Arab J. Inf. Technol.* 18, no. 3 (2021): 306-311
<https://doi.org/10.34028/iajit/18/3/6>
 11. Malik, S. and Sahu, P.K., 2020. Performance analysis of free space optical communication system using different modulation schemes over weak to strong atmospheric turbulence channels. In *Optical and Wireless Technologies* (pp. 387-399). Springer, Singapore
https://doi.org/10.1007/978-981-13-6159-3_41
 11. Elsayed, E.E. and Yousif, B.B., 2020. Performance enhancement of M-ary pulse-position modulation for a wavelength division multiplexing free-space optical systems impaired by interchannel crosstalk, pointing error, and ASE noise. *Optics Communications*, 475, p.126219.
<https://doi.org/10.1016/j.optcom.2020.126219>
 12. Andreje, Ž. and Batagelj, B., 2021. Vrednotenje tehničnih lastnosti komunikacijskega omrežja majhnih satelitov Starlink. *Elektrotehnikski vestnik*, 88(1/2), pp.1-7.
<https://ev.fe.uni-lj.si/1-2-2021/Andrejc.pdf>
 14. Sri, I.K. and Srinivasulu, A., 2019. Performance Analysis of Inter-satellite Optical Wireless Communication Using 12 and 24 Transponders. In *Proceeding of the Second Microelectronics, Computing & Communication Systems (MCCS 2017)* (pp. 811-821). Springer, Singapore
https://doi.org/10.1007/978-981-10-8234-4_66
 15. Patnaik, B. and Sahu, P.K., 2012. Inter-satellite optical wireless communication system design and simulation. *IET Communications*, 6(16), pp.2561-2567.
<https://doi.org/10.1049/iet-com.2012.0044>
 16. Sharma, V. and Kumar, N., 2013. Improved analysis of 2.5 Gbps-inter-satellite link (ISL) in inter-satellite optical-wireless communication (IsOWC) system. *Optics Communications*, 286, pp.99-102.
<https://doi.org/10.1016/j.optcom.2012.08.055>
 17. Pandi, V.S., Singh, M., Malhotra, J. and Grover, A., 2021. A spectral-efficient 1 Tbps terrestrial free-space optics link based on super-channel transmission. *Optical and Quantum Electronics*, 53(5), pp.1-12.
<https://doi.org/10.1007/s11082-021-02931-x>
 18. Anyanhun, A.I., Anzagira, A. and Edmonson, W.W., 2020. *Intersatellite Communication: An MBSE Operational Concept for a Multi-orbit Disaggregated System*. *IEEE Journal on Miniaturization for Air and Space Systems*, 1(1), pp.56-65
<https://doi.org/10.1109/JMASS.2020.3001080>
 19. Kumar, N., 2014. Enhanced performance analysis of inter-satellite optical-wireless communication (IsOWC) system. *Optik*, 125(8), pp.1945-1949.
<https://doi.org/10.1016/j.jjleo.2013.11.008>
 20. Lu, K., Xiao, G. and Chlamtac, I., 2005. Analysis of blocking probability for distributed lightpath establishment in WDM optical networks. *IEEE/ACM Transactions on networking*, 13(1), pp.187-197.
<https://doi.org/10.1109/TNET.2004.842233>
 21. Ravishankar, C., Gopal, R., BenAmmar, N., Zakaria, G. and Huang, X., 2021. Next-generation global satellite system with mega-constellations. *International Journal of Satellite Communications and Networking*, 39(1), pp.6-28
<https://doi.org/10.1002/sat.1351>
 22. Singh, M., Malhotra, J. and Dhasarathan, V., 2020. A high-speed single-channel inter-satellite optical wireless communication link incorporating spectrum-efficient orthogonal modulation scheme. *Microwave and Optical Technology Letters*, 62(12), pp.4007-4014
<https://doi.org/10.1002/mop.32511>
 23. Sharma, P. and Meena, S., 2018, July. Performance Analysis of Inter-Satellite Optical Wireless Communication (Is-OWC) System by using Channel Diversity Technique. In *2018 Inventive Research in Computing Applications (ICIRCA)* (pp. 477-480). IEEE
<https://doi.org/10.1109/ICIRCA.2018.8597344>
 24. Khichar, S. and Inaniya, P.K., 2018, April. Inter-Satellite Optical Wireless Communication System Design Using Diversity Technique with Filter and Amplifier. In *2018 Communication and Signal Processing (ICCSP)* (pp.0481-0484). IEEE.
<https://doi.org/10.1109/ICCSP.2018.8524366>
 25. Chaudhary, S., Sharma, A. and Singh, V., 2019. Optimization of high speed and long haul inter-satellite communication link by incorporating differential phase shift key and orthogonal frequency division multiplexing scheme. *Optik*, 176, pp.185-190.
<https://doi.org/10.1016/j.jjleo.2018.09.037>
 26. Karpagarajesh, G., Krishnan, R.S., Robinson, Y.H., Vimal, S., Kadry, S. and Nam, Y., 2021. Investigation of digital video broadcasting application employing the modulation formats like QAM and PSK using OWC, FSO, and LOS-FSO channels. *Alexandria Engineering Journal*. <https://www.sciencedirect.com/science/article/pii/S1110016821004014>
 27. Viswanath, A., Jain, V.K. and Kar, S., 2015. Analysis of earth-to-satellite free-space optical link performance in the presence of turbulence, beam-wander induced pointing error and weather condi-

tions for different intensity modulation schemes. IET Communications, 9(18), pp.2253-2258.

<https://doi.org/10.1049/iet-com.2015.0379>

28. Pradhan, S., Sahu, P.K., Giri, R.K. and Patnaik, B., 2017, December. Inter-satellite optical wireless communication system design using diversity techniques. In 2017, Optical and Communication Engineering (ICMOCE)(pp.250-253).IEEE
<https://doi.org/10.1109/ICMOCE.2015.7489738>



Copyright © 2023 by the Authors.
This is an open access article distributed under the Creative Commons

Attribution (CC BY) License (<https://creativecommons.org/licenses/by/4.0/>), which permits unrestricted use, distribution, and reproduction in any medium, provided the original work is properly cited.

Arrived: 09. 09. 2022

Accepted: 23. 12. 2022